



OPERATIONS

HYDRA-PULL MANURE SPREADER

VERTICAL BEATER MODEL 1880VB



Pik Rite, Inc
60 Pike Rite Lane
Lewisburg, PA 17837
Ph. 800-326-9763
Fx. 570-523-8175
www.pikrite.com

May 20, 2014

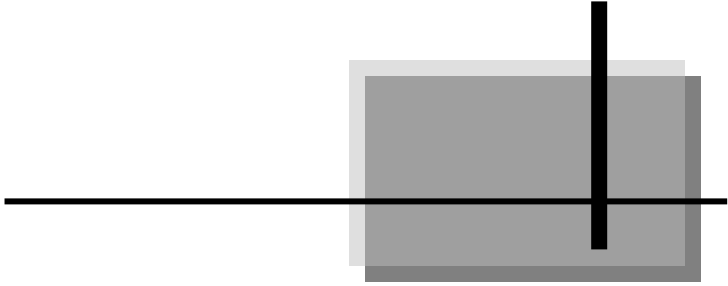

SOME ILLUSTRATIONS MAY NOT REPRESENT THE
SPREADER MODEL YOU HAVE; HOWEVER, THE
PRINCIPLES OF OPERATION AND MAINTAINENCE ARE THE
SAME. IF YOU HAVE QUESTIONS SPECIFIC TO YOUR
SPREADER PLEASE CONTACT YOUR DEALER.



HYDRA-PULL MANURE SPREADER, 1880VB SHOWN

(SPECIFICATIONS AND DESIGN SUBJECT TO CHANGE WITHOUT NOTICE)

Warranty

Pik Rite, Inc. provides a limited warranty assuring the Hydra-Pull Spreader to be free from defects in material and workmanship for a period of two (2) years from the original date of purchase. Pik Rite will repair or replace, at its option and without charge, any defective or malfunctioning part (excluding items of normal wear or misuse) of the spreader for this allotted time.

**PIK RITE MAKES NO WARRANTY OF
MERCHANTABILITY OR FITNESS FOR A
PARTICULAR USE.**

TABLE OF CONTENTS

SAFETY	8
PREPARING THE TRACTOR	18
PREPARING THE SPREADER.....	21
CONTROLS	24
ATTACHING THE SPREADER	26
DETACHING THE SPREADER.....	29
TRANSPORTING.....	30
OPERATING THE SPREADER.....	33
ATTACHMENTS	37
LUBRICATION & MAINTENANCE	38
SPECIFICATIONS	45

SAFETY

RECOGNIZE SAFETY INFORMATION

This is the safety-alert symbol. When you see this symbol on your machine or in this manual, be alert to the potential of personal injury.

Follow recommended precautions and safe operating practices



UNDERSTAND SIGNAL WORDS

A signal word – DANGER, WARNING, or CAUTION—is used with the safety-alert symbol. DANGER identifies the most serious hazards.

DANGER or WARNING safety signs are located near specific hazards. General precautions are listed on CAUTION safety signs. CAUTION also calls attention to safety messages in this manual.



FOLLOW SAFETY INSTRUCTIONS

Carefully read all safety messages in this manual and on your machine safety signs. Keep safety signs in good condition. Replace missing or damaged safety signs. Be sure new equipment components and repair parts include the current safety signs. Replacement safety signs are available from your Pik Rite dealer.

Learn how to operate the machine and how to use controls properly. Do not let anyone operate without instruction.

Keep your machine in proper working condition. Unauthorized modifications to the machine may impair the function and/or safety and affect machine life.

If you do not understand any part of this manual and need assistance, contact your Pik Rite dealer.



SAFETY

KEEP SHIELDS IN PLACE

Do not operate spreader without safety shields in place.

Rotating parts can crush or dismember causing death or personal injury.

Disconnect PTO driveline and hydraulic lines from tractor before removing shields for adjustment or service.



PROTECT BYSTANDERS

Never operate the spreader near people.

Do not place rocks, timbers or other solid objects in the spreader. Objects can be thrown great distances causing injury to people.



OPERATE SPREADER SAFELY

Rotating parts can entangle or strike people, resulting in death or personal injury.

Never enter a spreader while in operation.

Operate the spreader from the tractor seat only.

Do not exceed load capacity of the spreader. (See Transporting section).

Reduce speed when turning or traveling on rough terrain. Avoid traveling over loose fill, rocks, ditches or holes.

When working on inclines or slopes, travel uphill or downhill. Keep tractor in gear when traveling downhill.



SAFETY

PARK SPREADER SAFELY

Park spreader on a level surface and block wheels.

Close endgate.

Secure jackstand with pin (A).

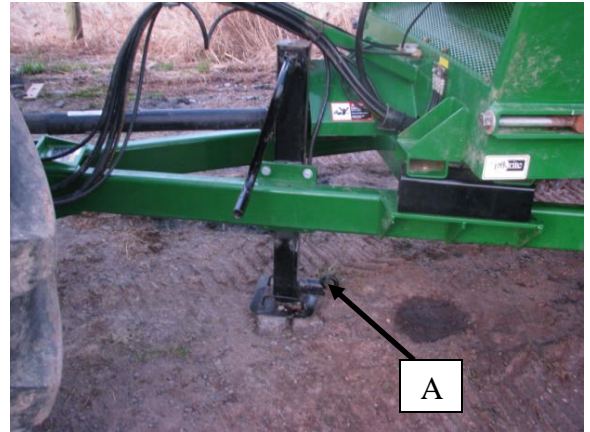

KEEP RIDERS OFF MACHINE

KEEP RIDERS OFF;

Riders are subject to injury such as being struck by foreign objects and being thrown off the machine. Riders also obstruct the operators view resulting in the machine being operated in an unsafe manner.



STAY CLEAR OF RAISED ENDGATE

Contact with a lowering endgate can cause death or personal injury.

Lower endgate and disconnect hydraulic lines before servicing or adjusting.



SAFETY

WEAR PROTECTIVE CLOTHING

Wear close fitted clothing and safety equipment, appropriate to the job.

Prolonged exposure to loud noise can cause impairment or loss of hearing.

Wear a suitable hearing protective device such as earmuffs or earplugs to protect against objectionable or uncomfortable loud noises.

Operating equipment safely requires the full attention of the operator. Do not wear radio or music headphones while operating machine.

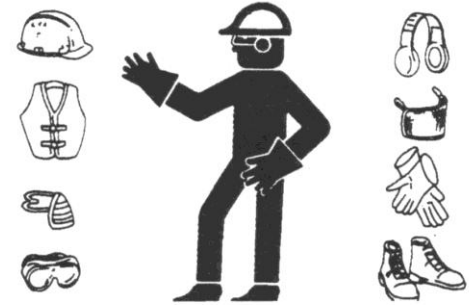

STAY CLEAR OF ROTATING DRIVELINES

Entanglement in rotating driveline can cause serious injury or death.

Keep tractor master shield and driveline shields in place at all times. Make sure rotating shields turn freely.

Wear close fitted clothing. Stop the engine and be sure PTO driveline is stopped before making adjustments, connections, or cleaning out PTO driven equipment.



STAY CLEAR OF ROTATING BEATER

Rotating beater can entangle or strike causing death or personal injury.

Do not clean out or service spreader while beater is rotating.

Disconnect PTO driveline and make sure all parts have stopped rotating before cleaning or servicing.



SAFETY

USE SAFETY LIGHTS AND DEVICES

Slow moving tractors, self-propelled equipment and towed implements or attachments can create a hazard when driven on public roads. They are difficult to see, especially at night. Avoid personal injury or death resulting from collision with a vehicle.

Flashing warning lights and turn signals are recommended whenever driving on public roads. To increase visibility, use the devices provided with your machine. For some equipment, install extra flashing warning lights.

Keep safety items in good condition. Replace missing or damaged items.

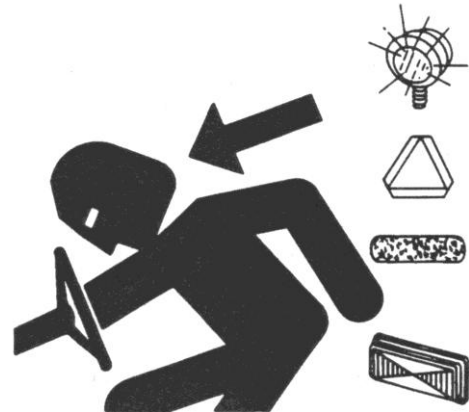

PREPARE FOR EMERGENCIES

Be prepared if a fire starts.

Keep a first aid kit and fire extinguisher handy.

Keep emergency numbers for doctors, ambulance service, hospital, and fire department near your telephone.

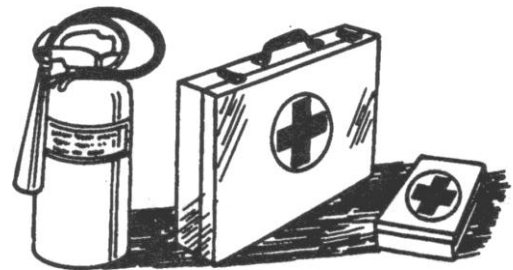

USE A SAFETY CHAIN

A safety chain will help control drawn equipment should it accidentally separate from the drawbar.

Using the appropriate adapter parts, attach the chain to the tractor drawbar support or other specified anchor location. Provide only enough slack in the chain to permit turning.

See your Pik Rite dealer for a chain with a strength rating equal to or greater than the gross weight of the towed machine. Do not use safety chain for towing.



SAFETY

REDUCE SPEED WHEN TOWING LOADS

Braking to stop towed loads from transport speeds can cause the towed load to swerve and upset. Reduce speed if towed load weighs more than the tractor and is not equipped with brakes.

Follow recommended speed-weight ratio guidelines:

- Maximum speed is 20 mph (32 km/h) when towing loads equal to or less than the tractor.
- Reduce speed to 10 mph (16 km/h) when towing loads more than equal and up to double the tractor weight.
- Do not tow loads exceeding double the tractor weight.
- Use additional caution when towing loads under adverse surface conditions, when turning, and on inclines.

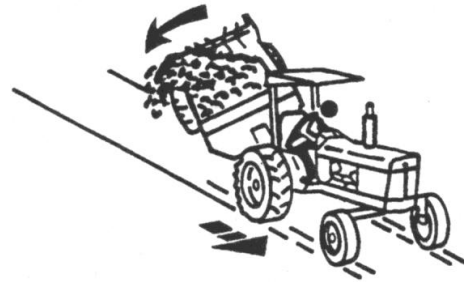

SERVICE SPREADER SAFELY

To help prevent personal injury caused by unexpected movement, be sure to service spreader on level surface.

If spreader is connected to tractor, disengage PTO, engage parking brake and/or place transmission in "PARK," shut off engine and remove key.

If spreader is detached from tractor, block wheels and use safety stands to prevent movement.

Replace all shields after lubricating or servicing.



SAFETY

AVOID HIGH-PRESSURE FLUIDS

Escaping fluid under pressure can penetrate the skin causing serious injury.

Avoid the hazard by relieving pressure before disconnecting hydraulic or other lines. Tighten all connections before applying pressure.

Search for leaks with a piece of cardboard. Protect hands and body from high pressure fluids.

If an accident occurs, see a doctor immediately. Any fluid injected into the skin must be surgically removed within a few hours or gangrene may result. Doctors unfamiliar with this type of injury should reference a knowledgeable medical source.





Both sides

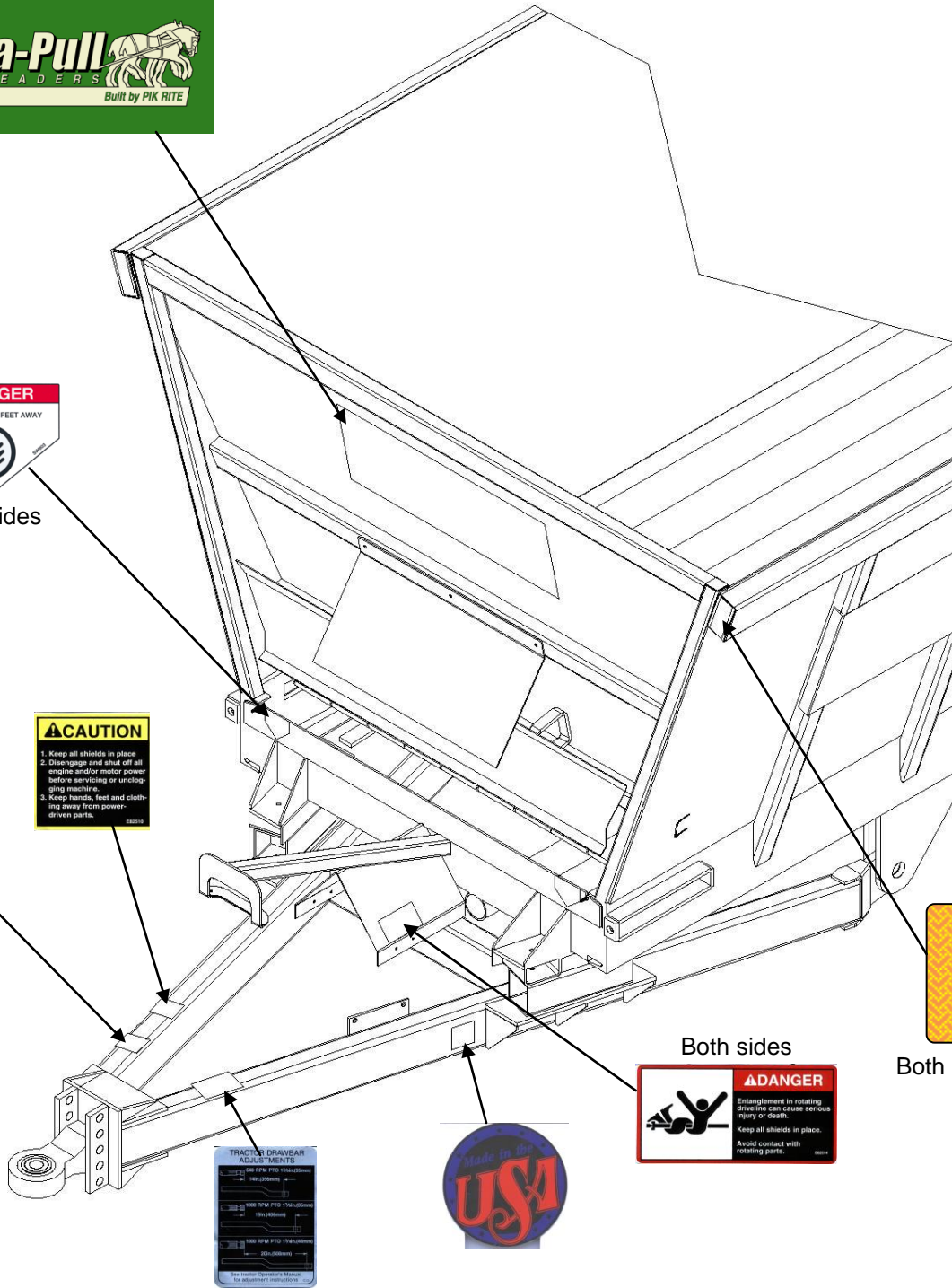

Both sides



Both sides





Both sides

1880 VB
Both sides



Both sides



Both sides



Both sides



Both sides



Both sides



Both sides



Both sides

PREPARING THE TRACTOR

APPROVED TRACTORS, MODEL 1880VB

Row Crop Tractors with 200 HP PTO rating or larger are approved for operation with the 1880VB Spreader.

Utility Tractors are NOT APPROVED because of drawbar weight limitations and the inability to ballast the tractor enough to meet requirements for towing.

A drawbar support is required on tractor with a drawbar size of no less than 1-1/2 x 3 in.

Tractor hydraulic oil reservoir must have capacity for 3.7 U.S. gal. net draw for spreader with endgate or 3.1 U.S. gal. without endgate.

Tractor standby hydraulic pressure must be between 1500 psi minimum

One selective control valves is required to operate the spreader.

A second selective control valve is required to operate the endgate.

CHOOSING CORRECT PTO SPEED

MODEL 1880VB – 1000 rpm only

IMPORTANT: Drive components can be damaged. Under no circumstances should a machine equipped for 540 rpm PTO be operated by a tractor equipped with 1000 rpm PTO. Nor should a 1000 rpm PTO machine be operated with a tractor equipped with 540 rpm PTO.

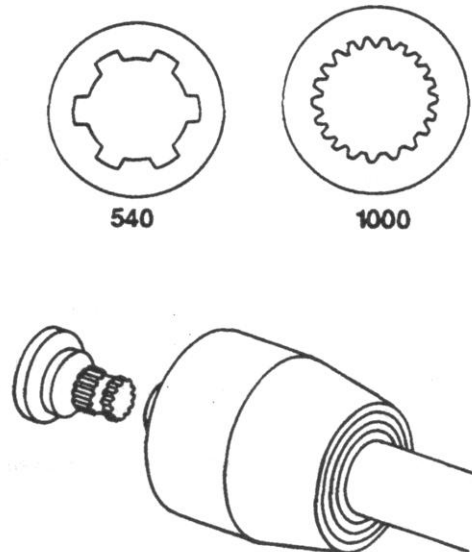

W11156 -UN-07OCT88

W9769 -UN-24JAN89

PREPARING THE TRACTOR

BALLASTING THE TRACTOR

CAUTION: Do not tow loads that weigh more than twice the tractor weight. (See Recommended Maximum Towing Speed in Transporting section.)

To ensure proper stability, adjust ballast and wheel spacing according to tractor operator's manual.

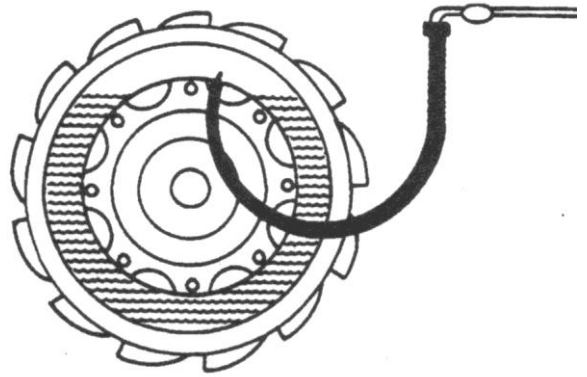

POSITIONING DRAWBAR

IMPORTANT: Tractor PTO and machine driveline can be damaged. Be sure drawbar length is properly set. If equipped with clevis, remove it. Lock drawbar along tractor centerline with offset down.

Clevis is needed

Adjust drawbar length (A) (see below) to help prevent driveline damage.

PTO Speed	Dimension (A)
1000 rpm x 1-3/4	508 mm (20in.)

A tractor drawbar support is required on tractor with a drawbar size of 1-1/2 x 3 in. minimum

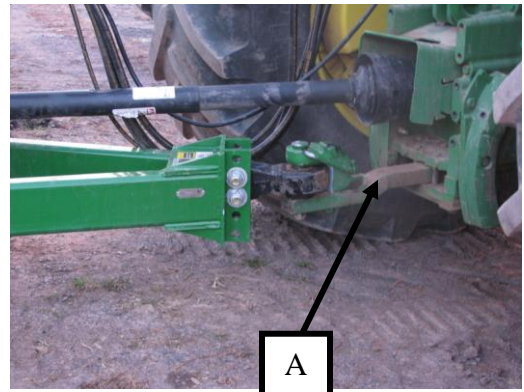

PREPARING THE TRACTOR

USING SELECTIVE CONTROL LEVERS TO CONTROL CHAIN SPEED

Apron Chain speed can be controlled by using tractor selective speed control lever to adjust spread rate up or down.

Adjust selective control valve lever to provide the slowest operating speed. (See your tractor operator's manual).

Maximum hydraulic oil flow through the spreader apron chain motor is 15 gpm. Trying to force through more oil than this, may create a pressure drop, and could damage the hydraulic motor.

SETTING HYDRAULIC SPEED ENDGATE OPERATION

IMPORTANT: Excessive operating speed may cause machine damage. Adjust selective control valve lever to provide correct operating speed.

CHECKING TRANSMISSION/HYDRAULIC OIL LEVEL

Cycle all hydraulic cylinders fully two or three times.

Fully retract all cylinders.

Check transmission/hydraulic oil level. (See your tractor operator's manual.)

PREPARING THE SPREADER

LUBRICATING THE MACHINE

Be sure the machine has been adequately lubricated.
(See Lubrication and Maintenance page.)

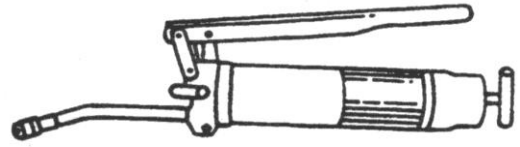

PREPARING THE SPREADER

TIGHTENING WHEEL HARDWARE

IMPORTANT: Operating the spreader with loose wheel hardware will damage the hub or wheel. Tighten hardware after initial transport, after one hour of operation, and every fifty hours thereafter.

Tighten to 475 lb-ft of torque in the sequence shown.

Tire Size	Wheel Size	Tire Pressure
700/40-22.5 treaded	22.5 x 16	65 PSI



BRAKE ADJUSTMENT (HYDRAULIC)

Valve is set from Factory at 1000 PSI.



PREPARING THE SPREADER

CHECKING TIRES

1. Check tires daily for damage or noticeably low pressure.
2. Repair any cuts or breaks as soon as possible.
3. Protect tires from exposure to sunlight and petroleum products or chemicals.



CONTROLS

OPERATING THE BEATER

To start beater, engage PTO lever slowly, at low engine rpm.

To stop beater, disengage PTO. (See your tractor operator's manual.)

For best spreading results, operate the tractor engine at "PTO RATED" speed.

Warning: Do not operate the apron chain without running the beaters as this may damage the spreader.

OPERATING THE ENDGATE

IMPORTANT: Contact of apron chain running with endgate closed will cause damage. To avoid contact with apron chain when running, endgate must be raised fully when running apron chain.

Operate the endgate with the second auxiliary control valve lever.

Warning: Endgate is not a metering device. Do so may cause damage to the spreader.



OPERATING APRON CHAIN

To run apron chain lock hydraulic control lever in operating position on tractor.

See your tractor's operating manual for information on how to control flow rates of your hydraulic system.

Maximum hydraulic oil flow through the spreader apron chain motor is 15 gpm. Trying to force through more oil than this may cause serious damage to motor (relief factory set at 1250psi.)

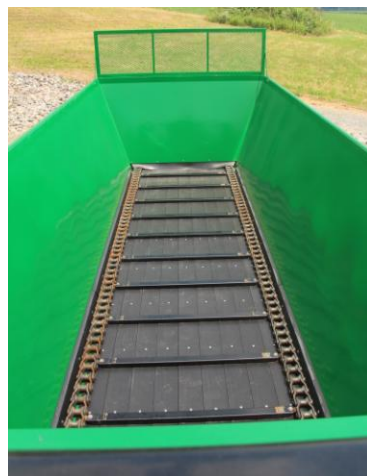

ATTACHING THE SPREADER

ATTACHING SPREADER

CAUTION: Help prevent personal injury caused by unexpected movement of the machine. Engage parking brake and/or place transmission in “PARK”, shut off engine, and remove key before working around hitch.

1. Attach with a 1-1/2 or 2 in. pin and secure. (Top clevis required)

IMPORTANT: Shorten safety chain to allow only enough slack required for turning.

2. Lock safety hook onto chain.



ATTACHING THE SPREADER

ATTACHING DRIVELINE

IMPORTANT: Avoid causing damage to shielding, **DO NOT** use bell on driveline to lift driveline into position.

1. Support driveline, cradling it in your hand.
2. Rotate driveline (C) or tractor PTO (B) to align splines.
3. Pull collar (C) rearward and push forward on bell (A) to engage driveline yoke with tractor PTO (B).
4. Pull back on PTO driveline shielding to be sure driveline is locked. **DO NOT** pull on collar, this will release latch.

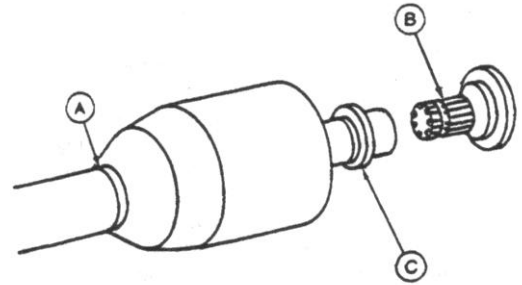

CONNECT HYDRAULIC HOSES

CAUTION: To avoid injury from escaping hydraulic oil under pressure, relieve the pressure in the system by shutting off the tractor and moving remote cylinder operating levers in both directions before attaching hoses to or detaching hoses from the breakaway couplers.



ATTACHING THE SPREADER (air assist brakes)

CONNECTING AIR HOSES

1. Connect red line to supply port.
2. Connect blue line to service/control port.



ATTACHING THE SPREADER (hydraulic brakes)

1. Connect pressure hoses to pressure ports of hydraulic remote coupler.
2. Connect return hoses to return ports of hydraulic remote coupler.

(Relief factory set 1000psi)



DETACHING THE SPREADER

DETACHING SPREADER

1. Secure jackstand in lift position
2. Detach safety chain.
3. Remove hitch pin.
4. Disconnect hoses. Store on spreader.



DETACHING DRIVELINE

1. Support driveline (A) and pull rearward on collar (C) to release driveline from tractor PTO (B).
2. When possible store driveline in driveline cradle provided with machine.
3. Replace tractor PTO shields.

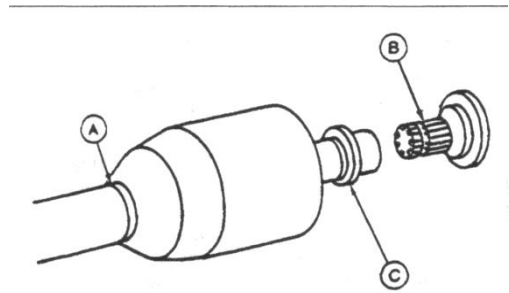

TRANSPORTING

USING A SAFETY CHAIN

CAUTION: A safety chain will help control drawn equipment should it accidentally separate from the drawbar while transporting. Using the appropriate adapter parts, attach the chain to the tractor drawbar support or other specified anchor location. Provide only enough slack in the chain to permit turning. See your Pik Rite dealer for a chain with a strength rating equal to or greater than the gross weight of the towed machine.

1. Attach safety tow chain.

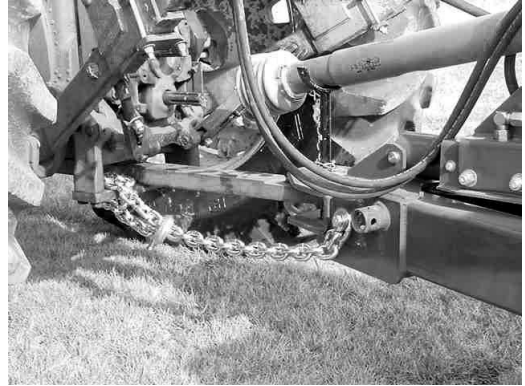

CAUTION: When transporting the machine on a road or highway at night or during the day, use accessory lights and devices for adequate warning to operators of other vehicles. Check local governmental regulations. Keep safety items in good condition. Replace missing or damaged items.

Contact your Hydra-Ram Dealer for available lighting kit.



TRANSPORTING

CAUTION: Braking to stop towed loads from transport speeds can cause the towed load to swerve and upset. Reduce speed if towed load is not equipped with brakes and weighs more than the tractor.

Follow recommended speed-weight ratio guidelines:

- Maximum speed is 20 mph (32 km/h) when towing loads equal to or less than the weight of the tractor.
- Reduce speed to 10 mph (16 km/h) when towing loads more than or up to double the tractor weight.
- DO NOT tow loads that exceed double the tractor weight.
- Use additional caution when towing loads under adverse road surface conditions (i.e. slippery or rough), when turning and/or on inclines.
- For proper tractor size and towing speed see the following “Recommended Maximum Towing Speed” chart.
- If necessary, add ballast as described in your tractor operator’s manual.

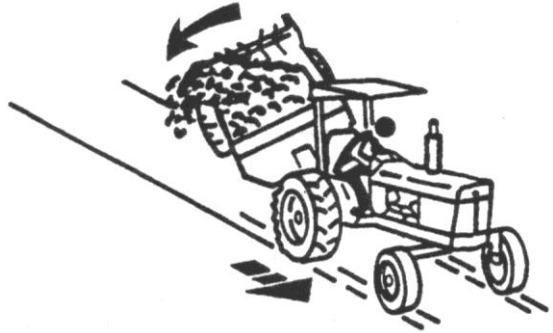

TRANSPORTING MODEL 1880vb

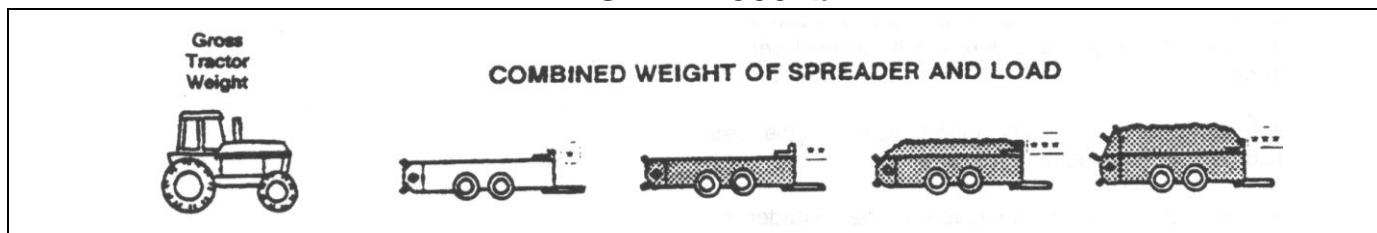

<u>Tractor Weight</u>				
(0-2997 lb)	Do Not Tow	Do Not Tow	Do Not Tow	Do Not Tow
(2998-5950 lb)	Do Not Tow	Do Not Tow	Do Not Tow	Do Not Tow
(5951-11021 lb)	Do Not Tow	Do Not Tow	Do Not Tow	Do Not Tow
(11022-12123 lb)	Do Not Tow	Do Not Tow	Do Not Tow	Do Not Tow
(12124-14769 lb)	Do Not Tow	Do Not Tow	Do Not Tow	Do Not Tow
(14770-22044 lb)	Do Not Tow	Do Not Tow	Do Not Tow	Do Not Tow
(22045-24910 lb)	(20 mph)	(10 mph)	(10 mph)	(10 mph)
(24911-29540 lb)	(20 mph)	(10 mph)	(10 mph)	(10 mph)
(29541 lb-Up)	(20 mph)	(10 mph)	(10 mph)	(10 mph)

**Base Spreader Empty Load*

***Load struck level consisting of manure with high liquid content. Calculated at 70 lb/cu ft*

****Load piled 381 mm (15 in.) above beater consisting of semi-solid type manure. Calculated at 55 lb/cu ft*

*****Load piled at 15 in. above optional upper beater consisting of semi-solid type manure. Calculated at 55 lb/cu ft*

OPERATING THE SPREADER

PREOPERATING CHECKS

1. Be sure spreader does not contain any foreign objects.
2. Check for correct hydraulic hookup. Raise endgate fully. Engage beaters, engage apron chain.
3. Disengage apron chain, disengage beaters.
4. Close endgate.

LOADING THE SPREADER

CAUTION: Do not place rocks, timbers, or other solid objects in the spreader. Objects of this nature can damage the spreader and could also be thrown great distances causing possible injury to anyone standing in the vicinity.

Load front of spreader first, distributing load evenly.

When operating without an endgate, avoid loading manure against the beater.



PREPARE TO UNLOAD THE SPREADER

CAUTION: Help prevent personal injury. Be sure no one is near spreader and tractor before operating.

1. Start beater by engaging PTO slowly at low engine rpm. Increase to “PTO RATED” speed.

NOTE: For best spreading results, operate tractor at “PTO RATED” speed.

Warning: Do not operate apron chain without running the beaters as this may damage the spreader

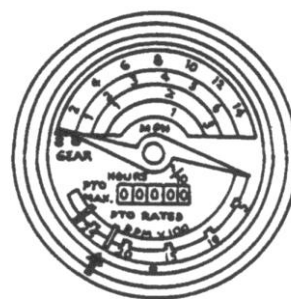

OPERATING THE SPREADER

RAISE ENDGATE

IMPORTANT: Contact of apron chain with endgate will cause damage. To avoid contact with apron chain, endgate must be raised fully.



UNLOADING SPREADER USING METERING VALVE

1. Set flow control on tractor hydraulics obtain desired rate of unload speed.

Note: Rate of spread is affected by both ground speed and unload speed. Experience will help you determine both gear selection and control knob setting.

2. When spreader is empty, disengage apron chain disengage PTO, and lower endgate.

OPERATING THE SPREADER

PRODUCING GOOD SPREADING RESULTS

1. Operate tractor engine at “PTO RATED” speed.
2. Do not overload beater. A clumpy spread pattern will result from too fast an unload rate.
3. When operating without an endgate, avoid loading material against the beater. Otherwise, large clumps of material will be thrown out during the first few turns of the beater.

CLEANING SPREADER IN COLD WEATHER

When operating the spreader during extended periods of subfreezing temperatures, frozen material may build up on steel surfaces. This can prevent the beater from moving.

After completing spreading for the day, use the following cleaning procedure.

NOTE: Cleaning is only necessary during extended *periods of subfreezing temperatures*.

Remove material along edges of apron chain

Remove material buildup from endgate panel.
Keep endgate arms clean to prevent freezing to side rails.

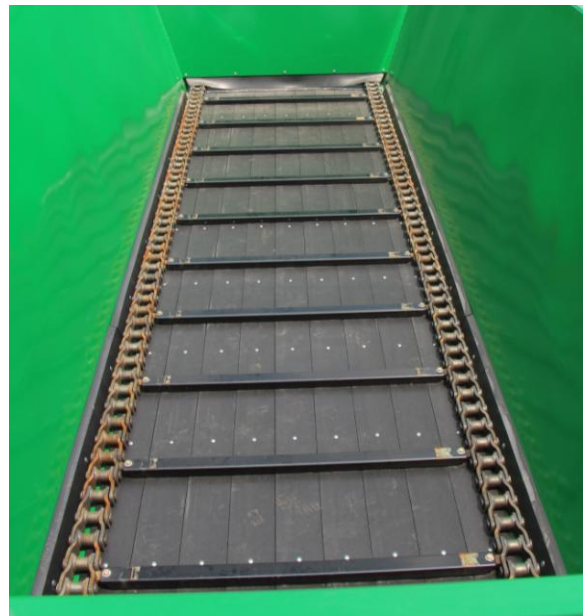

OPERATING THE SPREADER

When tire valve stems are mounted towards the inside, clean top of walking beams to prevent valve stem damage.



WARMING HYDRAULIC OIL TEMPERATURES BELOW 0°F (-18°C)

It is necessary to warm the hydraulic oil for proper spreader operation.

Follow the procedures in your tractor operator's manual for warming hydraulic oil.

The following procedures apply only to tractors with a closed center hydraulic system.



BYPASSING SPREADER CONTROL VALVE

There will be a large hydraulic oil pressure drop across the auxiliary flow control valve when the oil is cold. Oil pressure available to hydraulic cylinders may be too low.

Try cycling the cylinders several times slowly so the cold oil in the cylinders is mixed with the warm oil in the tractor. In the event of extreme cold; you may need to bypass the control valve to do this. Be sure you begin by moving the cylinders very slowly.

Reconnect hoses to flow control valve.

ATTACHMENTS

ENDGATE

The endgate closes off the back end of the spreader to contain manure with high liquid content.

The endgate also prevents solid material from being piled tight against the beater.



LUBRICATION & MAINTENANCE

LUBRICATING AND MAINTAINING SPREADER SAFELY

CAUTION: Help prevent personal injury caused by unexpected movement of the machine. If spreader is connected to tractor, disengage PTO, engage parking brake and/or place transmission in "PARK", shut off engine, and remove key. If spreader is detached, block wheels and use safety stands.

Replace all shields after lubricating or servicing.

OBSERVING INTERVALS

IMPORTANT: The intervals recommended are based on normal conditions. Severe or unusual conditions may require more frequent attention.

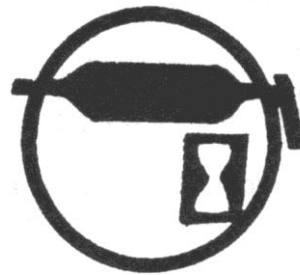

SELECTING GREASE

Depending upon the expected air temperature range during the service interval, use grease as shown on the adjusting temperature chart.

-SAE-Multipurpose High Temperature Grease with Extreme Pressure [EP] Performance with 3 to 5% molybdenum disulfide.

NOTE: Moly-type grease is recommended, however, if not available, a multipurpose grease is acceptable.

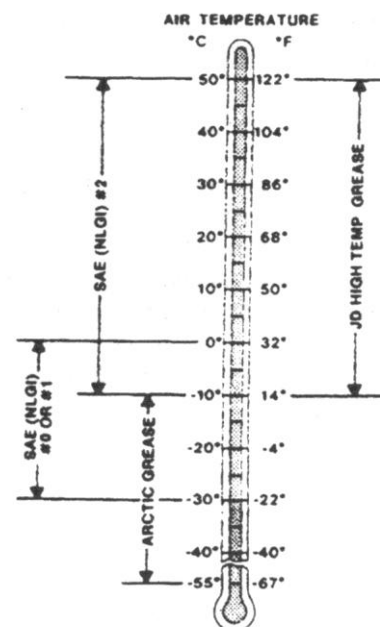

LUBRICATION & MAINTENANCE

SELECTING GEAR CASE OIL

Depending upon the expected air temperature range during the drain interval, use oil viscosity shown on the adjoining temperature chart.

- API Service Classification GL-5
- Military Specification MIL-L-2105B
- Military Specification MIL-L-2105C

At temperatures below -35° [-31°], use arctic oils such as those meeting Military Specifications MIL-G-10324A.

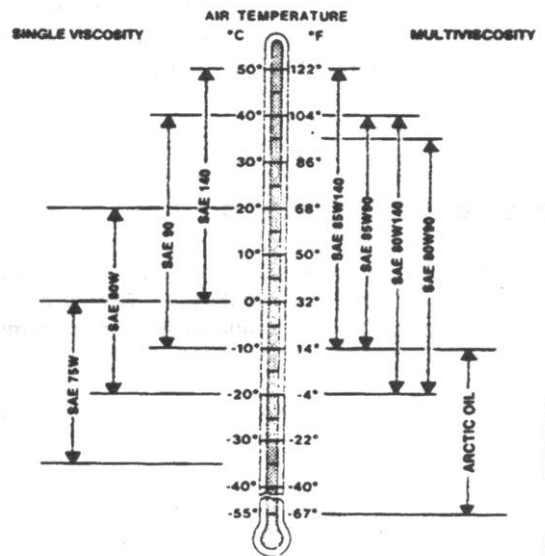

X9322 -19-30SEP88

SERVICE INTERVALS

- Lubricate driveline every 8 hrs
- Lubricate top beater bearings every 40 hrs
- Check gear case oil level every 8 hrs
- Check tires every 8 hrs
- Check axle hub oil every 8 hrs
- Grease apron chain drive bearings & sprockets every 40 hrs

EVERY 50 HOURS

- Adjust apron chain
- Tighten wheel hardware
- Lubricate walking beam pivots

EVERY 250 HOURS

- Lubricate endgate pivots

SERVICE AS REQUIRED

- Adjust apron chain tension
- Slip the clutch

GEARBOX

- Change lubricant every 6,000 loads

LUBRICATION & MAINTENANCE

In addition to the above referenced information, you are working with a central lube CV design on the primary that contains a special lubrication provision that needs to be well defined for the user so that extended life on the CV can be achieved.

The key point is that each CV has one zerk in a bearing cap and it is this zerk that is most important since it feeds the inboard cross kit as well as the the ball and socket of the CV. The user needs to understand that the zerk in the cap should receive **15-20 pumps** of grease each day while the other zerks in the joint,

CV housing and telescoping members can operate with 5-6 pumps or until the seals purge. The plastic zerks feeding the shielding should also receive 3-4 pumps daily if shields are being restrained.

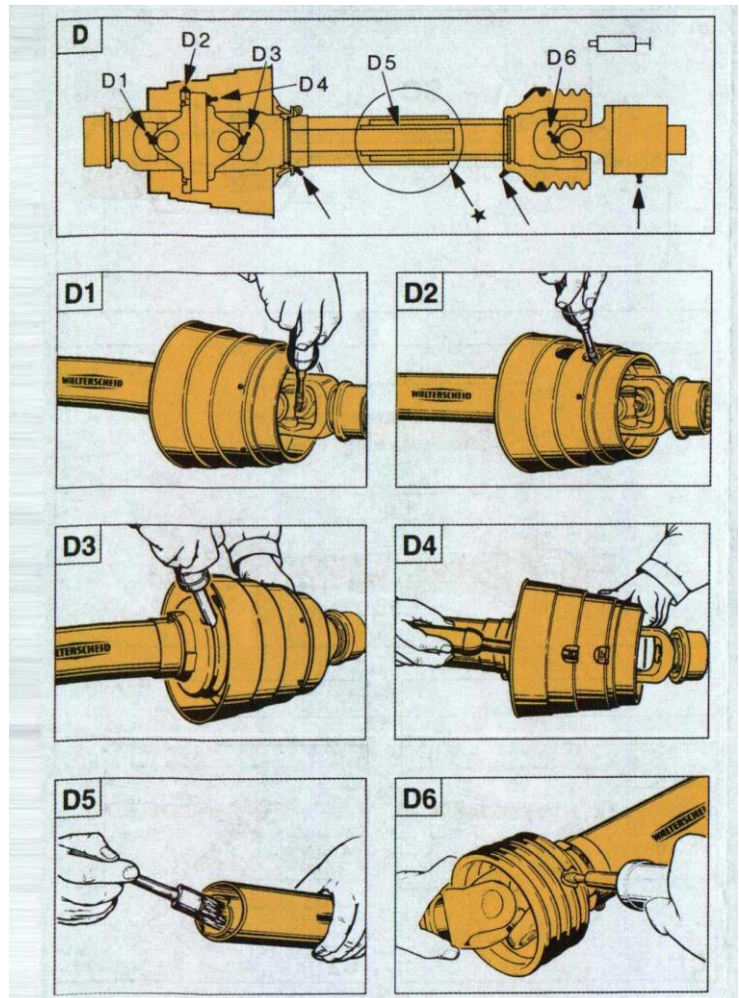

Primary Driveline (to Tractor) Lubricate fittings D1 through D6 every eight hours of operation.
Secondary Driveline (under spreader) Lubricate as above including overrunning clutch.

NOTE: Lubrication step D5 is only necessary when driveline does not have grease fitting. Separate front and rear halves of driveline and brush with grease.

LUBRICATION & MAINTENANCE

CHECK GEAR CASE OIL LEVEL

With spreader on level ground, check oil level at the sightglass on the center gearcase."A"

Add recommended oil as needed. (See Selecting Gear Case Oil.) To add oil, remove fill cap at the top of the gearcase "B".

B
A

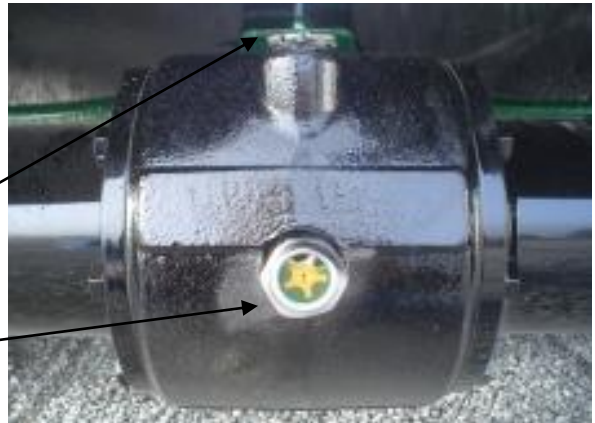

GREASE TOP BEATER BEARINGS

Grease the two bearings at the top of the vertical beaters every 8 hours of operation. Rear grease bank on beater side panel

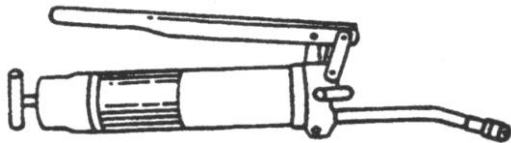

LUBRICATION & MAINTENANCE

CHECKING TIRES

1. Check tires daily for damage or noticeably low pressure.
2. Repair any cuts or breaks as soon as possible.
3. Protect tires from exposure to sunlight and petroleum products or chemicals.

Tire Size	Wheel Size	Tire Pressure
700/40-22.5 treaded	22.5 x 16	65 PSI



LUBRICATE WALKING BEAM PIVOTS

1. Place a jack under the spreader main frame.
2. Raise spreader enough to relieve weight from walking beam.
3. Lubricate grease bank (A) with Moly High Temperature/Extreme Pressure Grease.



TIGHTENING WHEEL HARDWARE

Operating the spreader with loose wheel hardware will damage the hub or wheel. Tighten hardware after initial transport, after one hour of operation, and every fifty hours thereafter.

Tighten to 475 lb.-ft. in the sequence shown.

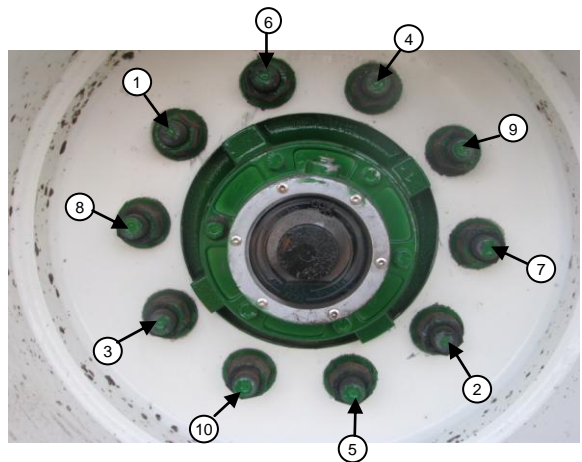

LUBRICATION & MAINTENANCE

CHECK OIL LEVEL IN HUBS.

See sight glass in hub for proper oil level.



LUBRICATE THE SIX PILLOW BLOCKS UNDER THE SPREADER THAT CARRY THE MAIN POWER SHAFT, USING CENTRAL GREASE LOCATION

1. Lubricate grease fitting (A) with Moly High Temperature/Extreme Pressure Grease.

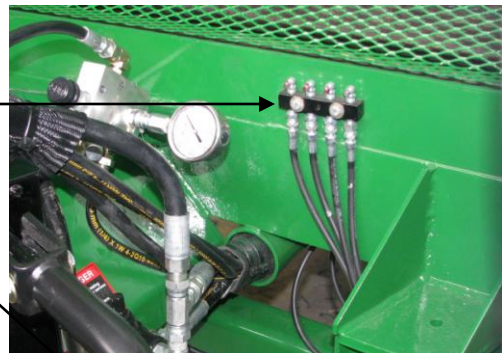
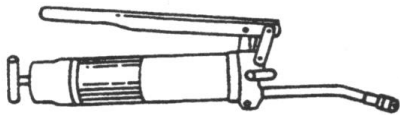

LUBRICATION & MAINTENANCE

**LUBRICATE WALKING BEAMS
USING GREASE BANKS
ATTACHED TO THE REAR OF THE
FENDERS, TWO ON EACH SIDE.**



**MAINTAINING SLIP CLUTCH,
WALTERSHIED**

The clutch is preset and is not field adjustable.

If you determine that your slip clutch needs maintenance or adjustment, contact your dealer.



LUBRICATE HITCH EVERY 40 HRS.



SPECIFICATIONS

MODEL 1880VB

Tractor Size (Minimum recommended)	200 hp PTO
Weight Spreader, Complete with Implement tires and all Attachments	17040 lb
Load Capacity	48400 lb
Volume Capacity Struck Level	712 cu. ft.
Heaped Load	1096 cu. ft.
Beater Speed	420 rpm
Unloading Speed	0-16 ft/min Infinitely Variable
Driveline	Shielded 1000 rpm
Attachments	Endgate

(Specifications and design subject to change without notice)